

IFC R2.0 Object Diagram - IfcColumn (vertical)

DRAWN BY JIRI HIETANEN / BLIS - PROJECT	REVISED 20.3.2000
---	----------------------

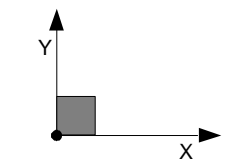

Transformation (red to black)
Z (Axis) 0,0,1
X (RefDirection) 1,0,0

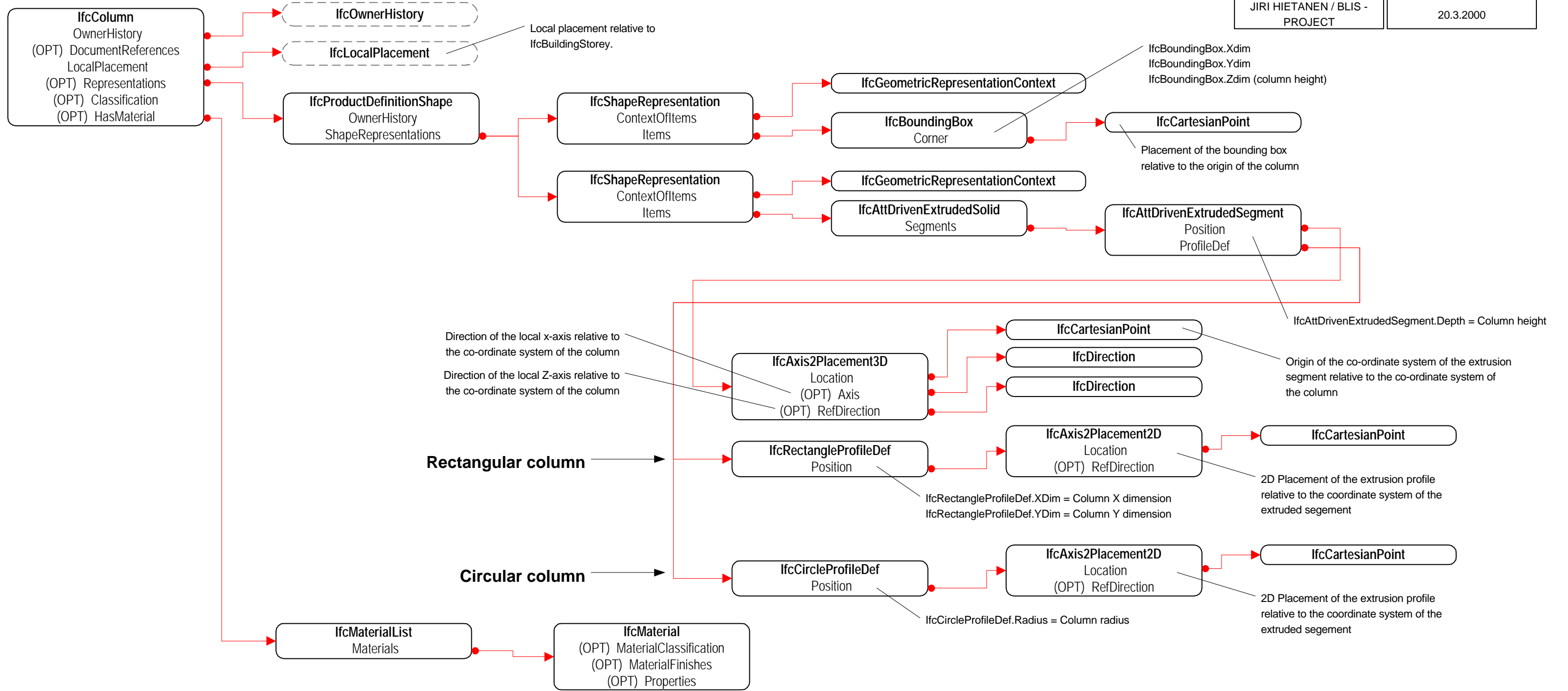
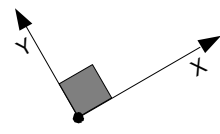

Transformation (red to black)
Z (Axis) 0,0,1
X (RefDirection) <value>, <value>, 0

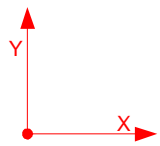

Local coordinate system for IfcBuildingStorey
Local coordinate system for IfcColumn
Local coordinate system for IfcExtrudedSegment

Column's local coordinate system

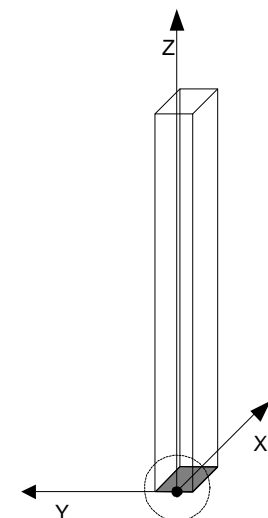

Bounding box dimensions

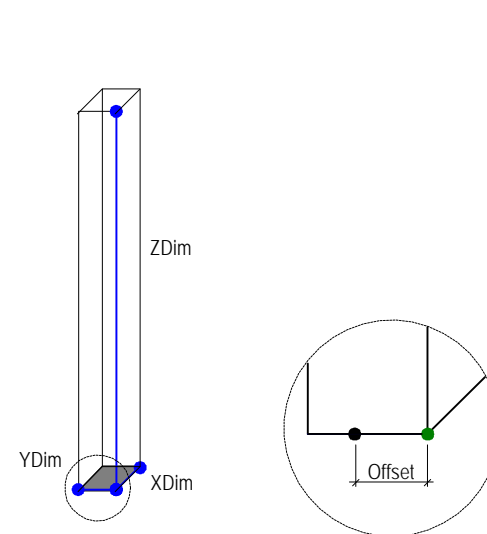

Standard geometric representation

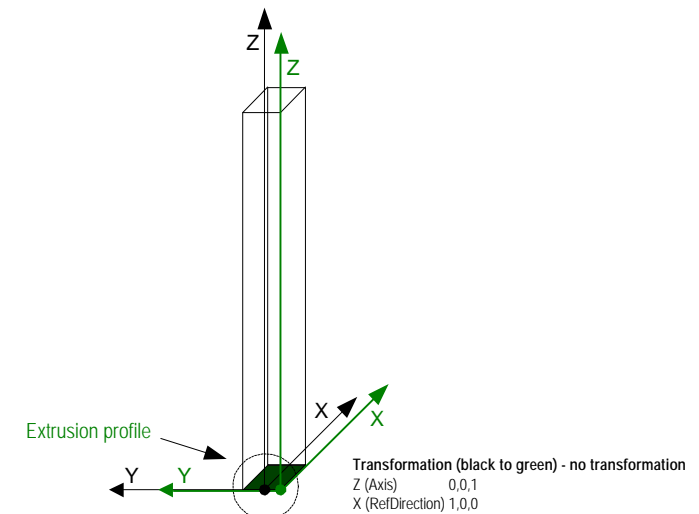

Transformation (black to green) - no transformation
Z (Axis) 0,0,1
X (RefDirection) 1,0,0